

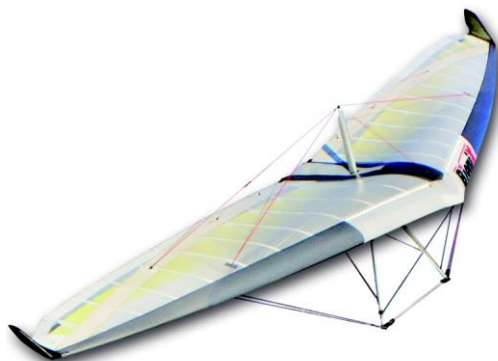

Pilot's Operating Handbook

Wing Type :

BioniX 15



615 Route de l'Aérodrome, 07200 Lanas, France

Telephone: +33 (0)4 75 93 66 66 • Fax: +33 (0)4 75 35 04 03

info@aircreation.fr • <http://www.aircreation.fr>

1 Table of Contents

1	Table of Contents	2
2	Amendment Record Sheet	4
2.1	Table of Amendments.....	4
2.2	Amendments.....	4
3	General	5
3.1	About this Document.....	5
3.2	3-Perspective Diagram.....	6
	<i>Figure 3-1: BioniX in 3 Perspectives</i>	6
4	Technical Specifications – Performance	7
4.1	Technical Specifications.....	7
4.2	Maximum Added Load / Trikes Adjustment	7
4.3	Performance at Maximum Take-Off Weight.....	9
5	Instructions for Use	10
5.1	Rigging.....	10
5.1.1	Assembly.....	10
	<i>Figure 5-1 : EasyFit Tighteners</i>	10
	<i>Figure 5-2 : Path of Tensioning Cables</i>	10
	<i>Figure 5-3 : Wing Tip Fin Fasteners</i>	11
	<i>Figure 5-4 : Central Trailing Edge Batten</i>	11
	<i>Figure 5-5 : Placement of Fairings</i>	11
	<i>Figure 5-6 : Closing the Velcros</i>	11
5.1.2	Disassembly	12
5.2	Preflight Check.....	12
5.3	Flight Specifications	14
5.3.1	Operational Limitations	14
5.3.2	Controls	14
	<i>Figure 5-7 : CORSET Control</i>	15
5.3.3	Flight Techniques	16

6	Appendix.....	21
6.1	Wing – Quality Form	21

2 Amendment Record Sheet

2.1 Table of Amendments

Amendment date	Affected sections	Affected pages	Date inserted	Signature

2.2 Amendments

The information in this manual is based on the data that was available at the time of its publication. The latest amendments to this manual will be issued on the Air Création website (<http://www.aircreation.fr>) in PDF format. This should be printed out and added to the manual. The amendment table should at that time be updated with the appropriate details and date. Therefore it is important for operators to check the website regularly for any amendments that have been made. If any errors or omissions are found in this manual please advise the factory.

3 General

3.1 About this Document

This manual is a legal document which is approved for use with Air Creation BioniX wing.

It must be used in conjunction with the particular trike's operating handbook.

It must remain with the aircraft, and not be amended or altered without authority from Air Creation.

All pilots should read this manual before flying as pilot in command of the aircraft to which it refers.

This manual is not intended to teach you how to fly the aircraft. Learning to fly should be accomplished under the supervision of a suitably qualified flight instructor experienced in flying this type of aircraft.

What this manual will do is provide the information necessary to a qualified pilot for the safe flight of this weight shift aircraft.

3.2 3-Perspective Diagram

Figure 3-1: BioniX in 3 Perspectives

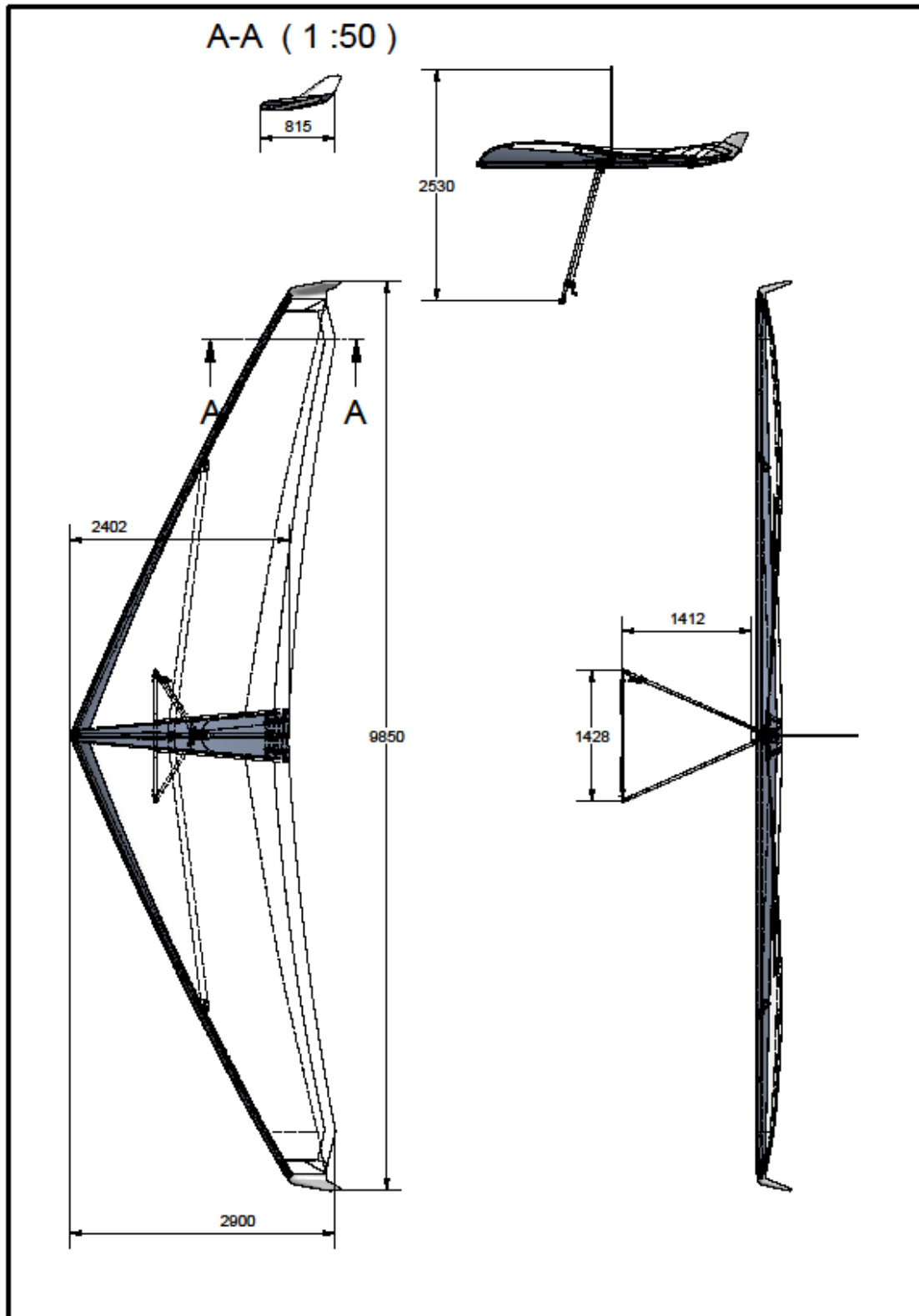

4 Technical Specifications – Performance

4.1 Technical Specifications

Area	15.1 sq.m. (162.54 sq.ft.)
Maximum wing loading	31.3 kg/sq.m. (6.4 lbs/sq.ft.)
Airfoil type	Double surface 90%
Span	9.85 m (32.3 ft)
Nose angle	130°
Aspect ratio	6.4
Empty weight	56 kg (123,5 lbs)
Ultimate load factors	+ 6g - 3g
Maximum take-off weight	472.5 kg (1,042 lbs)
Limit load factors	+ 4g 0g (-2g under gust)

4.2 Maximum Added Load / Trikes Adjustment

The maximum load that may be added under the wing is **416.5 kg (918 lbs)**. The following chart defines the useful load of our various trike models with the BioniX 15 wing.

Trike	Lst Skypper 582 / S	Lst Skypper 912 (S)	TANARG 582	TANARG 912	TANARG 912 S (ES)
Empty weight *	203 kg	224 kg (226 kg)	223 kg	242 kg	244 kg (239 kg)
	448 lbs	494 lbs (498 lbs)	492 lbs	534 lbs	538 lbs (527 lbs)
Useful load * with BRS parachute**	259.5 kg	238.5 kg (236.5 kg)	239.5 kg	220.5 kg	218.5 kg (223.5 kg)
	572 lbs	526 lbs (521 lbs)	528 lbs	486 lbs	482 lbs (493 lbs)
Useful load * w/o parachute	247 kg	226 kg (224 kg)	227 kg	208 kg	206 kg (211 kg)
	545 lbs	498 lbs (494 lbs)	501 lbs	459 lbs	454 lbs (465 lbs)
Maximum takeoff weight with parachute**	472.5 kg	472.5 kg	472.5 kg	472.5 kg	472.5 kg
	1042 lbs	1042 lbs	1042 lbs	1042 lbs	1042 lbs
Maximum takeoff weight w/o parachute	450 kg	450 kg	450 kg	450 kg	450 kg
	992 lbs	992 lbs	992 lbs	992 lbs	992 lbs

* optional equipment excluded ** French regulations

 **Caution:** *fitting of any equipment or any other change should never lead to exceeding the maximum empty weight value mentioned above, according to security standards and aircraft conformity.*

It is possible to adapt other trikes than the ones mentioned above. Their maximum weight should be less than 416.5 kg (918 lbs) fully loaded. *The stability of the trike alone must be absolutely positive in yaw* in order to guarantee the stability at high speed.

Then progressive tests will be performed to check the adaptation wing/trike, especially concerning the position of the control bar and the thrust line height. The necessary engine power for safe two-seater flight should be at least 60 HP. *Check during fitting whether the trike propeller stays clear of the lower rear longitudinal cables and the keel. A minimum clearance of 10 cm (4 inches) should be respected when the hang point is set to the front position and the wing is fully nose up and all the way banked on one side.*

4.3 Performance at Maximum Take-Off Weight

Trike	Lst Skypper 582 / S	Lst Skypper 912 (S)	TANARG 582	TANARG 912	TANARG 912 S	TANARG 912 ES
Stall speed	62 km/h	62 km/h	62 km/h	62 km/h	62 km/h	62 km/h
	39 mph	39 mph	39 mph	39 mph	39 mph	39 mph
Minimum speed	65 km/h	65 km/h	65 km/h	65 km/h	65 km/h	65 km/h
	40 mph	40 mph	40 mph	40 mph	40 mph	40 mph
Recommended climbing speed	80 km/h	80 km/h	80 km/h	80 km/h	80 km/h	80 km/h
	50 mph	50 mph	50 mph	50 mph	50 mph	50 mph
Take-off run	100 m	90 m (80 m)	105 m	95 m	85 m	90 m
	328 ft	295 ft (263 ft)	345 ft	312 ft	279 ft	295 ft
50 ft clearing distance	225 m	210m (180 m)	230 m	215 m	185 m	195 m
	738 ft	689 ft (591 ft)	755 ft	705 ft	607 ft	640 ft
Climb rate	3.3 m/s	4.6 m/s (5.6 m/s)	3.3 m/s	4.6 m/s	5.6 m/s	5.1 m/s
	650 ft/mn	906 ft/mn (1102 ft/mn)	650 ft/mn	906 ft/mn	1102 ft/mn	1004 ft/mn
Recommended approach speed	85 km/h	85 km/h	85 km/h	85 km/h	85 km/h	85 km/h
	53 mph	53 mph	53 mph	53 mph	53 mph	53 mph
Landing distance from 50 ft height	150 m	150 m	150 m	150 m	150 m	150 m
	492 ft	492 ft	492 ft	492 ft	492 ft	492 ft
Max L/D ratio	8.5	8.5	9	9	9	9
Max glide ratio speed	80 km/h	80 km/h	80 km/h	80 km/h	80 km/h	80 km/h
	50 mph	50 mph	50 mph	50 mph	50 mph	50 mph
Side wind limits	15 kts	15 kts	15 kts	15 kts	15 kts	15 kts
V.N.E. (velocity never to exceed)	185 km/h	185 km/h	185 km/h	185 km/h	185 km/h	185 km/h
	115 mph	115 mph	115 mph	115 mph	115 mph	115 mph
V.man (never to be exceeded in very turbulent air)	124 km/h	124 km/h	124 km/h	124 km/h	124 km/h	124 km/h
	77 mph	77 mph	77 mph	77 mph	77 mph	77 mph
Roll rate at 120% V min. (45°/45°)	3 s	3 s	3 s	3 s	3 s	3 s

5 Instructions for Use

5.1 Rigging

5.1.1 Assembly

1. Open the wing bag, make sure that the A-frame is on top, and remove fastenings and paddings.
2. Assemble the A-frame with the push-pin. Cables must not pass through the inside.
3. Lift the wing from the front and rotate it so that the wing is laying with the assembled control frame flat on the ground. Carefully open the two half wings to their maximum extent.
4. Slip the tensioning handle behind the foot of the king post **taking care to pass the cables under the front central strap that links the two nose battens in front of the king post foot** (Figure 5-2).
5. Fit the king post plastic head at the top of the king post without entangling pitch lines.
6. Fit the king post onto its locating lug on the keel, between the two tensioning cables, taking care not to cross them and not to pinch the flexible neoprene central link.
7. Carefully slide the upper sail bent battens in their respective pockets and tension the sail by fastening the Easyfit tighteners (Figure 5-1).

Figure 5-1 : EasyFit Tighteners



Figure 5-2 : Path of Tensioning Cables



8. Pull the cross tube swan catch tensioner towards the trailing edge, inside the triangle formed by the retaining strap of the central battens on the keel behind the king post and under the pulleys blocks of the CORSET, then hook it to the rail screw at the keel tip (Figure 5-2). To ease the operation, carefully center the A-frame, ensure that the tabs and heat shrink coverings of the lower lateral cables do not get stuck in the sail opening at the cross tube/leading edge connection and that the stainless steel tabs line up with the control bar.
9. Pull down the swan catch tension lever and fix it in the rail with the pushpin.
10. Raise the nose of the wing and lift it on its A-frame. To avoid dragging the tips of the wing on the ground, it is recommended that a second person hold the back of the keel.
11. Fix the front lower longitudinal cables in the rail under the nose plate with the help of the swan catch tension lever and the pushpin.

12. Carefully slide the lower sail battens in their pockets and secure them within the triangular openings.
13. Place the two straight carbon battens of the wing tips on the plastic lug attached to the tube of the leading edge, and tighten the upper surface with the clasps.
14. Mount the wing tip fins by introducing them between the upper surface and the lower surface, as well as between the straight carbon batten and the upper surface fabric. Push upwards the 3 Dart locking pins to ease the positioning of the tip fins, then return them to their slots and secure them by turning clockwise. (Figure 5-3). Tighten the under surface of the wing tip by means of its bungee that should encircle the clasp of the upper surface (Figure 5-3).

Figure 5-3 : Wing Tip Fin Fasteners



Figure 5-4 : Central Trailing Edge Batten



15. Close the two zippers of the neoprene central link. Insert the trailing edge tensioning batten in the nylon slots at the ends of the two central battens by pulling back (Figure 5-4).
16. When connecting the trike, slip the security fastening cable behind the kingpost, then through the loop in the security strap aligned with the front of the kingpost, behind the kingpost again, and then fix it to the beam of the trike. The security cable should pass under the tensioning cables and between the fine cord of the CORSET and the keel. This operation secures the trike as well as fastening the crossbar tensioning system.
17. Attach the fairings to the kingpost and the struts of the A-frame. Firmly press the trailing edge of the fairings all along with the palm of two hands during assembly. Repeat the operation while pinching the trailing edge with the fingers. Figure 5-5 & Figure 5-6.

Figure 5-5 : Placement of Fairings



Figure 5-6 : Closing the Velcros

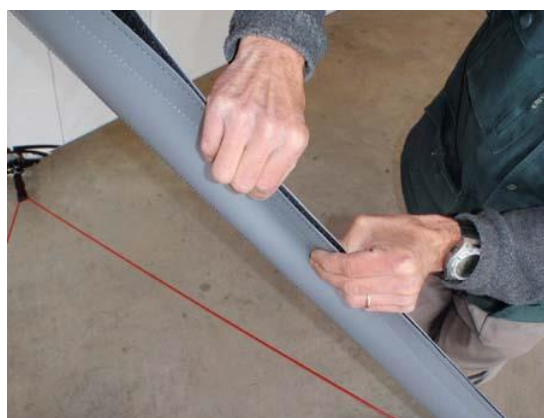

For the final stage of lifting the wing on the trike, follow the instructions in the trike operating handbook.

5.1.2 Disassembly

Dismantling is carried out in reverse order of the assembling operations. The CORSET must imperatively be loose (set in the “slow” position) before dismantling.

Before setting the wing flat on the ground, insert the protective padding on the keel over the hang point bracket and on the right A-frame strut over the guides of the fine cord of the CORSET in order to avoid damaging the sail with these jutting parts.

Before folding up the two half-wings, place the leather cap on the tensioning device lever and slip it inside the sail *at the front of the kingpost foot* to avoid tearing any part of the sail or the frame while closing the leading edges.



Never release the tension of the wing without first removing the tip fins and the carbon battens of the wing tips.

5.2 Preflight Check

The wing preflight check will be easier if made before lifting the wing above the trike. The following is a brief summary of the minimum pre-flight inspection, which assumes that the scheduled maintenance checks outlined in the maintenance manual has been performed. If you are unsure, it does no harm to increase the number of items in your inspection in accordance with the recommendations of the maintenance manual.

1. Position the wing horizontally once coupled with the trike.
2. Visually check the symmetry of the two leading edges.
3. Check noses plates assembly, bolts, nuts, thimbles and Nicopress of the front lower longitudinal cables, swan catch correctly positioned, pushpin and wires attached.
4. Slide your hand along the leading edges to check for possible damage. Make sure the profile of the upper surface of the leading edge is free of deposits of raindrops, insects, snow or ice. Clean/dry if necessary.
5. Check the crossbar/leading edges connection, bolts, nuts, by unzipping the lower surface access. Check for correct fastening of lower flying wires and upper landing wires, also their condition, swages and thimbles. Check that the sail is not snagged on a metallic part. Close the lower surface access.
6. Check the fastening of the sail at the wing tips and the position lock of the two pivoting sleeves by means of the Parker screws.
7. Check the fitting, the security and the condition of the tip fins.
8. Check the fitting of the upper surface battens and the closure of their tighteners on the trailing edge.
9. Check that all lower surface battens are fully pushed home and make sure that their ends are engaged in the triangular openings in the fabric.
10. Check fitting and condition of the reflex bridles and their attachment to the sail.
11. Check that no upper cables are wrapped around the kingpost and that the luff lines are well positioned in the grooves of the pulleys at the top of the kingpost.
12. Check the thimbles and swages of the rear lower cables at the keel end.
13. Check the correct routing of the tensioning cables **under the strap in front of the kingpost, then on each side of the king post, inside the triangle formed by the retaining strap of the central battens on the keel behind the king post and under the pulleys blocks of the CORSET**. Check the tensioning system at the end of the keel, the nuts and bolts, the correct position and security of the push pin.
14. Check the condition of the elastic central link of the upper surface, the fitting of the central tensioning batten of the trailing edge, and the security of the central zippers by means of the split rings.
15. Check the Velcro closures of the keel pocket and under surface, the condition and security of the stitching of the retaining straps of the sail on the central battens.
16. Check the correct routing of the fine cord of the CORSET through each pulley of the pulleys blocks and through the angle pulley of the hang bracket.
17. Slide your hand along all of the the lower cables to detect signs of wear.
18. Check that the lower cables are attached to the A frame, check the nuts and bolts, check the condition of the cables and their Nicopress clamps, and the push-pin of the control bar. All the cables should be loose enough to pivot in the direction of the tension. Close the leather cover webbings.
19. Check the attachment, the condition, and the working order of the control handle of the CORSET (See 5.3.2 “CORSET”).
20. Look through the openings in the center of the under surface to check the cross tube junction, nuts and bolts, cover webbing, keel retaining straps, and the fitting of the tensioning cables.
21. Check the hang bracket for condition (possible twist, cracks) and free pivoting movement. The butterfly nut and security ring must be in place on the trike to wing attachment bolt.
22. Check that the safety cable of the hook is correctly positioned and fastened. It must pass under the tensioning cables, and between the fine cord of the CORSET and the keel. This system ensures the fastening of the trike as well as tensioning of the crossbars in case of failure of one of the main components.
23. Check the complete closure of the fairings of the kingpost and A-frame struts (*adhesion of the trailing edge Velcros all along their surfaces*).
24. Check that all zippers are closed, all Velcro fastened, and that the nose bonnet is in the correct position with the Velcro’s stitched together.

5.3 Flight Specifications

5.3.1 Operational Limitations

 **Warning:**

This wing is not designed for aerobatics.

It is imperative to respect the flight envelope !

- Maximum Pitch attitudes 30° nose up, 30° nose down
- Maximum Bank angle 60°
- Aerobatics and deliberate spinning prohibited
- V.N.E. (never to be exceeded): 115 mph (185 km/h)
- Maximum Take-Off Weight 472.5 kg (1042 lbs)
- Acceleration limits +4/-0g ; positive "g" at all times
- Stalls authorized only in glide path with a progressive speed reduction and throttle to idle position.

 ***Over these limits, stability problems, structural failure or irreversible "tumbling" motions may occur.***

Ideal handling will only be reached after about 10 flight hours and roll control will be stiffer during the first flights.

 ***Do not fly without the nose bonnet. This streamlining has considerable effect over pitch and roll stability of the wing. Its lack alters the internal pressure of the sail, which may result in great modifications of the airfoil shape.***

5.3.2 Controls

Control bar:

Pushing the control bar forward causes the wing to pitch its nose up, which increases the angle of attack (causing the aircraft to climb) – primary effect, and a decrease in air speed – secondary effect.

Roll control is effected from lateral movement of the control frame, and follows weight shift convention, i.e. bar right, aircraft rolls to the left.

A separate yaw control is not provided. Like other weight shift aircraft, yaw is provided from the secondary effect of banking.

CORSET:

The CORSET allows the pilot to adjust both the trim speed and the configuration of the wing (twist and reflex) according to speed. At low speeds, the twist increases, the reflex of the central profile decreases, thus affording better handling and the lowest stall speed. At high speeds, cruising stability is given preference, as is aerodynamic efficiency. Its operation is transparent to the pilot and may be compared to that of the trim in a classical pitch system.

To increase trim speed, push and turn the control lever clockwise. When you stop turning, and release the lever, the reel is blocked. Maximum speed configuration is attained when the fine cord reaches the back end of the opening, next to the “bird at high speed” icon located on the base of the control lever (Figure 5-7). To decrease trim speed, push and turn the control lever counterclockwise. Minimum speed is attained when the fine cord reaches the front end of the opening, next to the “bird at low speed” icon. Do not try to turn the lever beyond this position in order not to effect an inverted reeling of the fine cord. For takeoff and landing approach, it is recommended to set the CORSET in the slow speed configuration.

In very turbulent conditions, the CORSET should be adjusted to the green swathes at the center of the color chart located on the base of the control lever (avoiding the yellow swathes at the ends of the chart), in order to limit use of high and low speeds to levels adapted to guarantee the best maneuverability of the wing.

On the ground, the CORSET control lever should be left in the slow position to limit tension on the sail.

Figure 5-7 : CORSET Control



5.3.3 Flight Techniques

Taxiing:

Avoid turning sharply as this generates large amounts of torque and hence wear, transmitted to the pylon, hang point and keel. Always try to keep the wing aligned with the trike when turning by bracing the control bar. Turning circle is very small, but beware – wing tips and tip fins stick out and can move around their arc very fast!

Take-off and landing techniques:

Take-off is conventional. Keep the aircraft straight using the nose wheel steering. Allow the bar to float in the neutral position in pitch and keep the wings level. Let the control bar move forwards to obtain takeoff rotation. As the aircraft rotates, allow the control bar to move back smoothly and allow airspeed to build.

If taking off in calm conditions or from a soft field or from a field with long grass, the minimum take-off roll distance is reached by increasing rpm to full power with brake, then releasing the brake and pushing the control bar fully forward. The control bar should be brought backwards immediately once the wheels are in the air to obtain a climbing speed ranging from 75 km/h to 80 km/h (47 mph to 50 mph) according to the load. If a performance take-off is not required then once the aircraft has rotated allow the bar to move back smoothly, adopt a shallow climb attitude and allow the airspeed to build to a safer low-level climbing speed of around 85 km/h (53 mph).

The landing is conventional. Maintain the approach speed until 8-10 foot height, then flare out to make a smooth touchdown. Braking may be used once all wheels are on the ground. A short landing requires a slow approach speed ranging from 75 km/h to 80 km/h (47 mph to 50 mph). Raise the nose a few meters from the ground, in order to touch down at stalling speed. Brake and pull the control bar to the maximum in order to obtain more aerodynamic braking once the rear wheels have touched ground. If conditions are gusty or a strong wind gradient is suspected, use a higher approach speed value.

Turning:

The BioniX wing is very well-balanced in the turn and is capable of high rates of roll with modest control forces. Roll rate is proportional to both airspeed and wing loading. Fastest roll rates will be achieved at light weights and high airspeed. Conversely when flying at high weight and low speed, maneuverability is reduced. Ensure that the runway is long enough for take-off and that no sudden maneuvering is required to avoid obstacles early in the climb, when speed may be low. Proper usage of the CORSET system allows to reduce in large part the variation in roll rate as a function of speed, variation inherent in flexwings (see 5.3.2).

Turns at bank angles up to 60 degrees are permitted. To balance the turn at this bank angle, forward bar movement is necessary to generate the required lift for level flight and increased power is required to overcome drag and maintain airspeed. Under these conditions substantial wake turbulence is produced. For turns of over 45 degrees of bank it is recommended that a heading change of no greater than 270 degrees is used, in order to avoid entry into the wake turbulence and a possible excursion outside the permitted flight envelope. The BioniX has neutral spiral stability at high cruise speed and thus will remain balanced in a turn without any roll control pressure required. With a high loading

and low cruise speed adjustment, it may be necessary to increase the speed before the wing is put into banking to avoid stalling the lower wing. An increase in engine power is also advised to maintain the flight level during the turn.

Stalling:

The stalling point is reached more easily with a backward hang point position. Once the stall angle of attack is reached, the control bar starts pushing back forcefully and some pre-stall buffet may be felt in the form of pressure bumps. Avoiding any resistance to this tendency for a short while allows the wing to return to correct speed. In that case, the loss of altitude will be less than 10 m. (33 ft) If the control bar remains extended despite the warning signs, the wing will stall and the loss of altitude may easily reach 30 m (100 ft). An asymmetrical start on one wing is possible, particularly during the running in of the sail (first 50 flying hours).

Nose high pitch attitudes generated prior to the stall break will lead to high nose down rotation rates. In common with all flexwing aircraft, extreme examples of this can result in tumbling motions, loss of control and massive structural failure.

 *To avoid risk of tumbling, stalling exercises must imperatively be carried out with the engine at idle, with a very slow decrease in speed (less than 1kt/sec) obtained by progressively pushing the control bar out.*

Pilots should also be aware that as with all aircraft, overloading with baggage/heavy occupants will increase stalling speed, as well as the usual drawbacks of reduced performance, maneuverability and structural safety margins.

Behavior in strong wind:

Once grounded and motionless

Park the aircraft perpendicular to the direction of the wind, with its windward wing lowered and the tip of the leading edge rests on the ground (the wing tip fins are mounted flexibly to allow the tip of the leading edge take the pressure if the wind is strong), block the A frame on the front tube of the trike (using for example the Velcro used for packing the battens of the sail), block the park brake and put chocks under all three wheels. Take the wing off the trike and put it flat on the ground windward, if the aircraft is not going to be used immediately.

Ground-runs

Keep the sail flat into a headwind. Push the control bar against the trike front strut with a tailwind. This will avoid flipping. With a side wind, be careful to always tilt the wing so that the windward edge is slightly lower than the rest of the wing.. It may be difficult to hold the A-frame in its position. Never let the wind lift the wing up.

Take-off and landing

As ground run distances are considerably reduced by strong wind, try to face the wind. Perform take-off and landing maneuvers at greater speed than you would normally do, in order to diminish the drift angle and counter the effects of the gradient.

Crosswind Take-off

Start the take-off run with the windward wing very slightly lowered. Hold the aircraft on the ground by holding the bar slightly back from the neutral position. Keep to the axis of the runway with the front wheel control without considering efforts on the sail. Allow airspeed to build to a higher-than-normal value then rotate positively into a shallow climb attitude. Keep the wings level and allow the trike to yaw into the relative wind. At this point adjust the drift angle if required to maintain runway centerline, and proceed as normal.

Crosswind Landing

Crosswind landing limits are largely dictated by the skill of the pilot. Make sure that you have lots of experience before attempting crosswind landings with components in excess of 8kt.

General technique should be to fly the approach maintaining the runway centerline by setting up a steady drift angle. During the final stages of the approach use a higher-than-normal approach speed to minimize the drift angle. Round out slightly lower than normal and aim for a short hold off, so that the aircraft lands smoothly, back wheels first with the control bar at or only slightly forward of the neutral position. The contact between the back wheels and the ground will then yaw the trike unit towards the runway centerline at which point the nose wheel can be gently lowered to the ground. Once all wheels are down the windward wing can be lowered slightly. To ensure maximum directional control during rollout from a crosswind landing the recommended technique is to move the bar back after landing and apply light to moderate braking. This eliminates any tendency to bounce and ensures good contact pressure between tire and runway surface. This technique of applying aerodynamic loading to increase ground pressure and hence braking efficiency during landing roll is also appropriate for short field landing.

Remember that crosswind landings on grass are slightly easier than on hard surfaces. During crosswind landings a lot of torque is carried through the structure which results in excessive wear to the hang point and attached structure. Always try to land into the wind if possible. If crosswind components are in excess of 15 knots then only a small windward distance will be required for landing – across a large runway could be the best option!

Flight in Turbulence:

Compared to other flexwing microlights, the BioniX handles turbulence very well. However in common with all microlight aircraft, care must be taken in turbulent conditions, particularly when close to the ground. As previously stated high airspeed will enhance maneuverability in these situations. However if conditions become severely turbulent with hard jolts being transmitted through the aircraft, it is recommended that you do not exceed the maneuvering speed V_{man} . V_{NE} should only be reached in smooth conditions.

In strong wind conditions, avoid flying on the downwind side of large hills or other obstructions. When landing in strong crosswind conditions, remember that low-level turbulence will be produced by obstructions on the upwind side of the runway. Always try to assess areas of possible lift, sink or turbulence from some distance away so that you can be fully prepared for their effects.

At height the best way to minimize pilot workload and physical fatigue is to fly the aircraft while trying to let the control bar float through turbulence. Use your arms as dampers and try not to rigidly fight the movement. Close to the ground, where accurate control is required, the displacement of the aircraft in turbulence can be reduced by bracing the control bar relative to the structure of the trike unit. This then transmits to the wing the pendulum stability of the trike mass. However the pilot must be ready to make any necessary corrective control inputs.

Smooth flight in turbulence in a flexwing aircraft is a skill that is learned with time and experience. Please remember the old adage: “It is better to be on the ground wishing that you were in the air, than in the air wishing that you were on the ground!”

Rain, ice and snow:



Flight in rain increases the stall speed of the aircraft and reduces maneuverability at slow speeds. The simple presence of raindrops scattered on the leading edge of the wing before or during flight increases stall speed by a factor of up to 10%.

We recommend wiping the fabric of the leading edge with an absorbent cloth if such conditions are observed before flight. During flight, so long as raindrops are present on the windshield of the trike, one must expect a higher stall speed, obtained with the control bar further back than usual. Be particularly careful in landing approach and raise the recommended speeds by 10%, especially if takeoff load is high.

Any other form of contamination of the leading edge, the airfoil, and the upper surface such as ice or snow will result in strongly increased stall speeds and a large reduction in overall aircraft performance. **Never take off under such conditions!** If these conditions are encountered during flight, attempt to escape these conditions as quickly as possible. If this is not possible, the aircraft should make an emergency landing as soon as it is safe to do so. During this process avoid flight at low speed and expect poor aircraft performance.

6 Appendix

6.1 Wing – Quality Form

Anxious to ensure the perfection of our products, we have set up a sequence of controls covering all steps of production. We are continuously working on their improvement and we are in need of your help.

Please return this reply form accurately filled in if you find any issues or problems concerning your trike that could affect its quality or finish, even if it is a minor matter.

Name
Address
Telephone
E-Mail
Type of Wing & Trike
Delivery Date
Wing Serial Number
Colors of Wing
Distributor
Hours Flown

Problems noticed: (explanations and/or drawing)



615 Route de l'Aérodrome, 07200 Lanas, France

Telephone: +33 (0)4 75 93 66 66 • Fax: +33 (0)4 75 35 04 03

info@aircreation.fr • <http://www.aircreation.fr>